

## TINDO KARRA 410W G2H



With over 10 years and six generations of high-tech Australian manufacturing excellence at Technology Park Mawson Lakes, **Tindo Solar's** latest module is the first from the new purpose built state-of-the-art manufacturing facility.

**Tindo** is synonymous for the highest standards of quality, durability and reliability. Recent independent reviews of module performance at the Government funded Desert Knowledge Australia Solar Centre (DKASC Alice Springs), confirms that **Tindo** outperforms ALL manufacturers modules tested currently available in Australia. Check out the **Tindo Solar** performance for yourself <http://dkasolarcentre.com.au/locations/alice-springs/graphs?sources=64>

Tindo Solar is committed to **ethical and sustainable supply chains**. We are a proud signatory of the UN Global Compact supporting a set of core values and policies regarding human rights, labour standards, the environment, and contributing to the UN Sustainable Development Goals.



### A Reliable Investment

Inclusive 25-year product warranty and 25-year linear performance warranty.



### Enduring high performance

Long-term yield security with Anti LID technology, anti PID technology, hot spot protect and traceable quality.



### Low Electricity generation costs

Higher yield per surface area, lower BOS costs, higher power classes, and an efficiency of up to 20.1%.



### State of the art module technology

Tindo Karra combines cutting edge cell separation and innovative wiring technology.



### Innovative All Weather Technology

Optimal yields, whatever the weather with excellent low-light and temperature behaviour, plus high salt mist resistance.



### Multi busbar half cut cell with PERC technology

Laser-cut monocrystalline cells reduce internal resistance for higher output, higher efficiency and increased durability.



# Tindo Karra 410W G2H

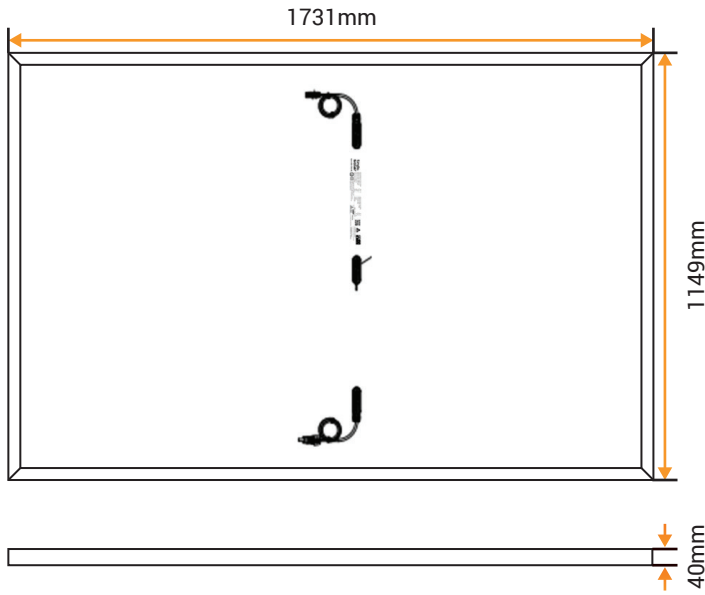

## Electrical Characteristics

108 Cell Module		Karra - 410G2H	
Item	Unit	*STC	*NMOT
Max. Power (Pmax)	Wp	410	301
Max. Power voltage (Vmp)	V	31.11	28.6
Max. Power current (Imp)	A	13.18	10.5
Open circuit voltage (Voc)	V	37.11	34.3
Short circuit current (Isc)	A	13.93	11.3
Panel efficiency	%	20.6	
Positive power tolerance	W	0 + ~ 5	

\*STC (Standard Test Condition): 1,000 W/m<sup>2</sup>, AM 1.5, 25°C / \*NMOT (Nominal Module Operating Temperature): 800W/m<sup>2</sup>, 20°C, wind speed 1m/s, Tolerance of Pmax, Voc & Isc ± 3% within each watt class at STC.

## Qualification Test

Thermal cycling test	-40°C to 85°C for 200 cycles
Damp heat test	85°C and 85% relative humidity for 1000 hr
Front Load test	3600Pa
Rear Load test	2400Pa
Hail Impact test	25mm hail at 23m/s from 1m distance

Cyclone tested by Structural Engineering Consultants Australia (SECA) Pty Ltd - certificate available on request.

Safety factor of \*static load test: 1.5 (Test load = Design load x Safety factor)

### Note:

- The specifications included in this datasheet are subject to change without notice.
- The electrical data given here is for reference purpose only.
- Please confirm your exact requirements with the sales representative while placing your order.
- Manufactured in Australia by Tindo Operations Co Pty Ltd, 6-8 Park Way, Mawson Lakes, SA 5095

## Mechanical Characteristics

Cells per panel	108 Half Cells
Cell Type	Mono-crystalline PERC (182x182mm)
Panel Dimension (Lx Wx Hx)	1731 x 1149 x 40mm
Panel Weight	21.5 Kg
Front Glass	Fully tempered ARC Glass (High Transmission)
Frame	Black Anodized Aluminum Alloy (T6)
Junction Box	With bypass diode / IP68 rated
Connector Type	KST4-EV02(M), KBT4-EVO2(F) /Stabli-MC4

## System Integration Parameters

Temperature Range	-40°C ~ +85°C
Maximum System Voltage	1,500 VDC (IEC)
Maximum Series Fuse Rating	25 A

## Thermal Characteristics

Rating	Unit	Value
*NMOT	C	44
Temperature Coefficient	Isc	%/C + 0.05
	Voc	%/C - 0.26
	Pmax	%/C - 0.34

NMOT: Nominal Module Operating Temperature

## Safety Ratings & Warranties

Safety Application Class	Class II
Fire Safety Classification	Class C
Certifications	IEC 61215 , IEC 61730
Warranty	25 years limited product warranty
Performance Guarantee	25 years limited warranty 80% power

## Packaging

Stacking Method	Horizontal / Palletised
Panels per Pallet	25
Pallet Dimensions & Weight	1780 x 1200 x 1200, 570kg
Pallets & Panels per 20-ft container	8 Pallets - 200 Panels
Pallets & Panels per 40-ft container high cube	18 Pallets - 450 Panels



Exclusive Reseller Program



1300 846 367  
tindosolar.com.au  
wholesale@tindosolar.com

